

I. Examples Of "No Call" Free Space to Goal (FSG) Situations

EXAMPLES OF "NO CALL" FSG SITUATIONS

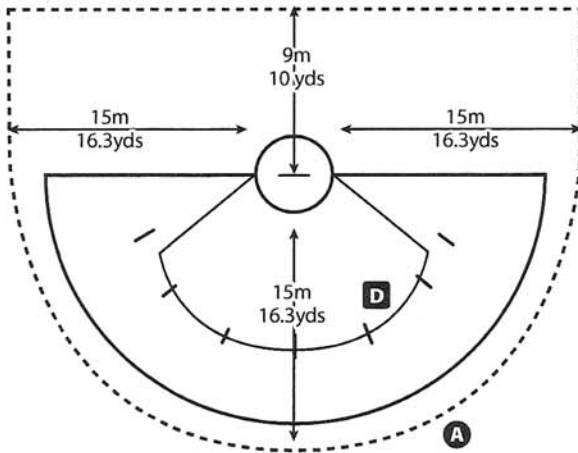

- A) **No Call.** Ball carrier is too far out. Ball not in Critical Scoring Area.

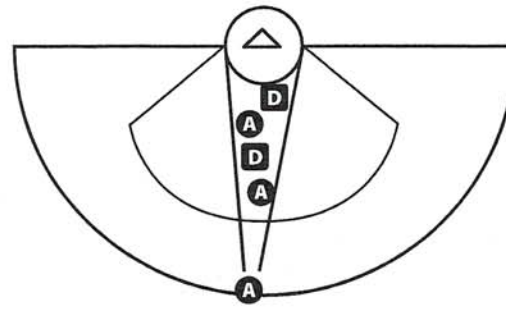

- B) **No Call.** Defenders are marking the attack within a stick's length.

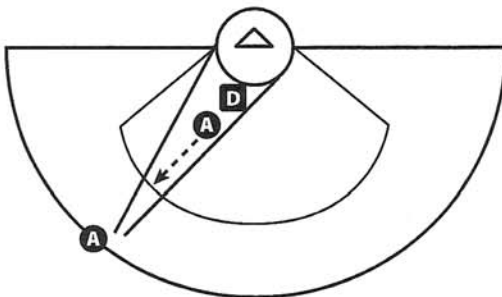

- C) **No Call.** The attack player is cutting toward her teammate, bringing her marking defender with her.

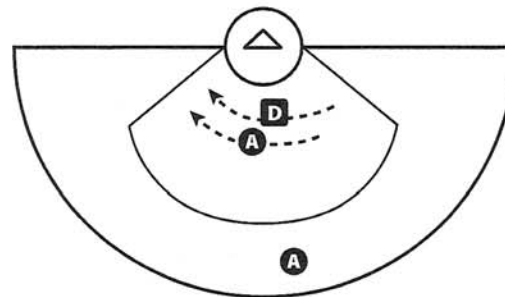

- D) **No Call.** Defender is marking her opponent as she cuts across the goal.

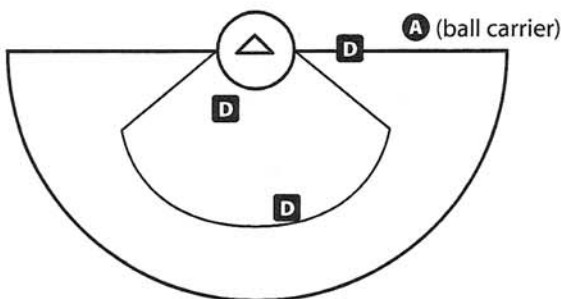

- E) **No Call.** Ball carrier is behind the goal line extended, and therefore, has no shot.

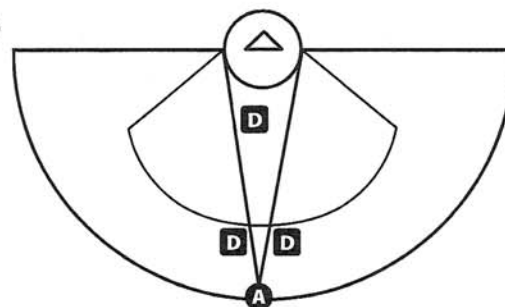

- F) **No Call.** Ball carrier is being marked by a legal double team and does not have a shot.

EXAMPLES OF "NO CALL" FSG SITUATIONS

"No Call" Free Space to Goal (FSG) Situations (Cont'd)

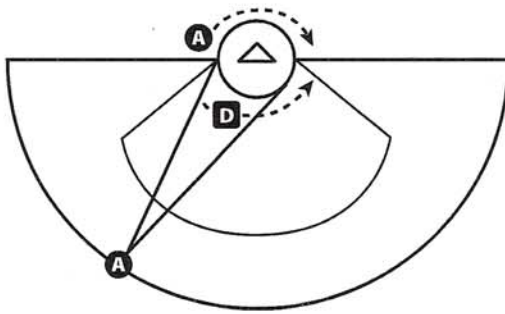

G) No Call. Defense is being drawn through the free space to goal by attack behind the goal. Defense must mirror movement of attack, move through quickly, and not hesitate.

Note: If the defender hesitates at all, she will be penalized for obstructing the free space to goal.

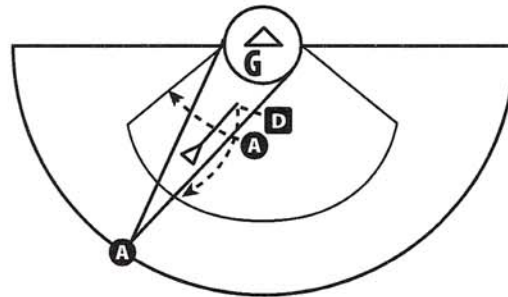

H) No Call. Defender decides to leave attack cutter to pick up ball carrier. Defender does so in such a way that she leads with her crosse keeping her body out of the free space to goal.

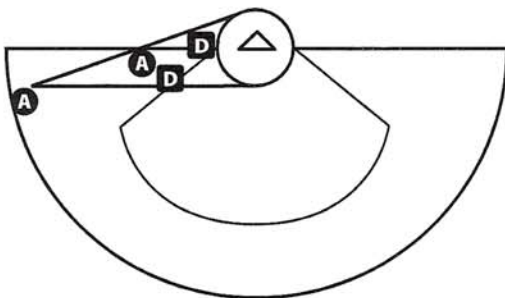

I) No Call. One defender is below the goal line and the other is marking an opponent with a stick's length.

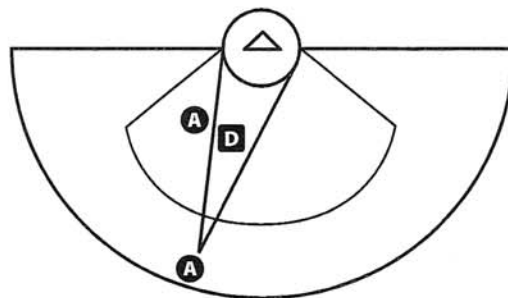

J) No Call. Defender may look as though she is the free space to goal, but if the defender is within a stick's length of the attack player she is marking, the defender is legal.

II. Examples Of "Call" Free Space to Goal (FSG) Situations

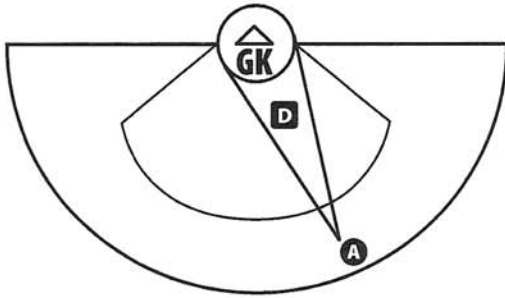

- A) **Call.** The Defender is just standing in the free space to goal.

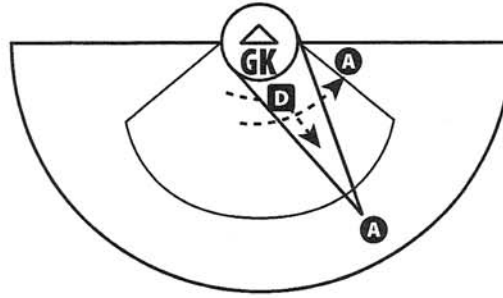

- B) **Call.** The attack has cut away, and her defender turns to play ball carrier.

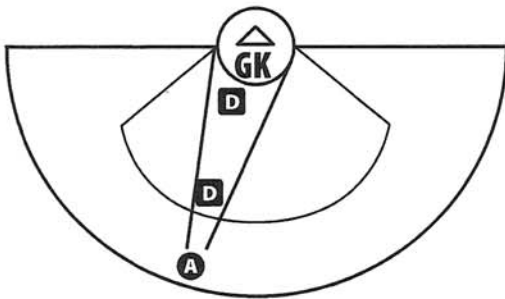

- C) **Call.** Ball carrier is marked but has a shot. Low defender is obstructing the free space to goal.

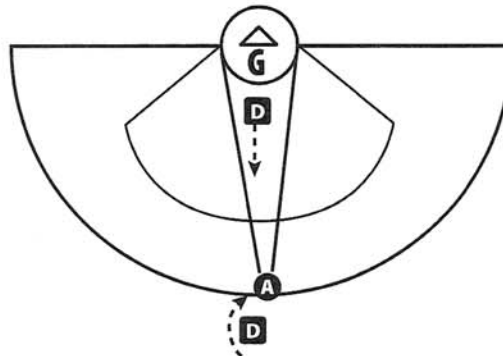

- D) **Call.** Ball carrier dodges first defender and the second defender is moving directly toward the ball carrier without getting her body out of the free space to goal.

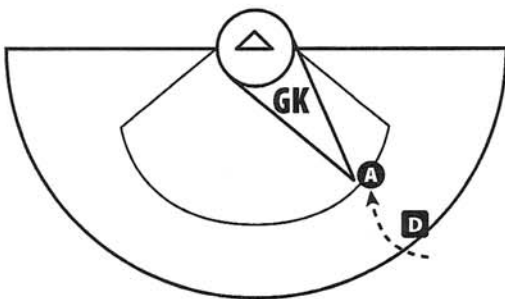

- E) **Call.** Ball carrier dodges defender. Goalkeeper who is well outside the goal circle makes no attempt to move up to mark the ball carrier. Goalkeeper assumes responsibilities of field player when she leaves the goal circle.

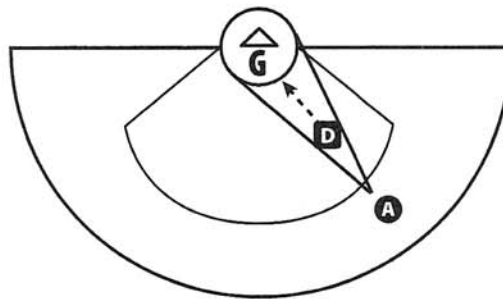

- F) **Call.** Instead of stepping up to mark the ball carrier, the defender stands or "back pedals" as the attack attempts a shot on goal.

EXAMPLES OF "CALL" FSG SITUATIONS

EXAMPLES OF ZONES & FREE SPACE OBSTRUCTION

III. Examples Of Zones & Free Space to Goal Obstruction

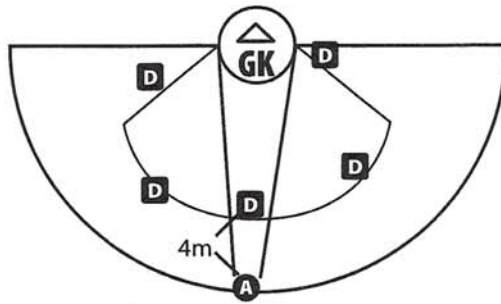

A) **Call.** Ball carrier looking to shoot as she enters the 12m fan. Defender stands on 8m arc making no attempt to step sideways out of the free space to goal or to step up and play the attack ball carrier.

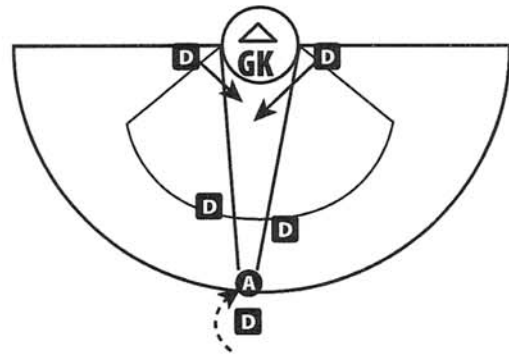

B) **Call.** Ball carrier dodges defender marking her. Two low defenders move into free space to goal. Both players are penalized by going 4m behind.

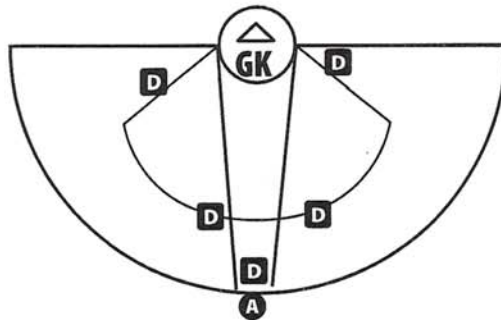

C) **No Call.** The front defender is legally marking the ball carrier, all other defenders are outside the free space to goal.

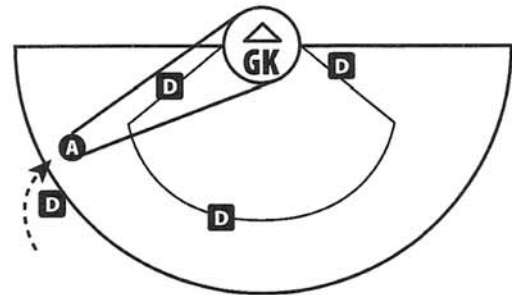

D) **Call.** Ball carrier dodges defender and is looking for a shot. Low defender is obstructing the free space to goal.

Note: Even though the low defender is outside the arc, she is still in the free space to goal.